

SIRIUS CAPACITOR MODULE

User Manual

Model number: 3550-48-B-1.7C-M-SD-A-TI

Version 1.0; Release Date: September 2019



Author:

Mamoona Khalid

Introduction

The Sirius Capacitor Module (“Sirius”) is supercapacitor-based storage that uses supercapacitors as storage cells instead of chemical cells. Kilowatt Labs’ proprietary balancing, control and charge retention algorithms control the operation of the supercapacitor-based modules, making Sirius a safe, efficient and effective alternative to chemical batteries wherever chemical batteries are deployed.

Legal Provisions

No part of this User Manual (“Manual”) may be reproduced, or transmitted, in any form or by any means, without the prior written permission of Kilowatt Labs, Inc. (“Kilowatt” or the “Company”). Specifications in this Manual are subject to change without notice. While every attempt has been made to make the Manual accurate and up-to-date, users are cautioned that product improvements may cause the Company to make changes to specifications without advance notice. Users are encouraged to consult the Company or its Resellers before using the Manual. Neither the Company nor its Resellers shall be liable for any indirect, incidental, or consequential damages under any circumstances caused by reliance on the material presented, including, but not limited to, omissions, typographical errors, arithmetical errors or listing errors in the content material. The content of this manual shall not be modified without the written authorization of the Company.

Trademarks

All trademarks are recognized, even if not explicitly identified as such. Kilowatt Labs® is a registered trademark of the Company.

Contents

1. Safety Instructions:	5
1.1 Symbols Convention:	5
1.2 Safety Precautions:	5
1.3 Modules Connection Safety Precautions:.....	6
1.4 Shipping:	7
1.5 Qualified Installer:.....	7
2. Product Introduction:	7
2.1 Product Part Number:.....	7
2.2 Product Overview:	8
2.2.1 Appearance:.....	8
2.2.2 Mechanical Drawings:.....	9
2.2.3 Dimensions and Weight:.....	11
2.3 Product Description:	11
8. Protected Terminal:	16
9. Unprotected Terminal:	17
3. Module Installation:.....	17
3.1 Inspection:	17
3.2 Safety Gear:	17
3.3 Unpacking and Contents Check:	18
4. Operation Procedures:.....	18
4.1 Module Configuration:.....	18
4.2 Software Configuration:.....	22
5. Recovery Procedure:.....	24
6. Connecting the Modules in Parallel or in Series:	25
6.1 Parallel Connection of Sirius Modules:	25
6.2 Series Connection of Sirius Modules:	26
7. Resistive Heater:	27
8. Automatic Safety Shutdown:	28
9. Trouble Shooting:	29
10. Features:	30
10.1 Key Features:	30
10.2 Physical features:	30
10.3 Technical Features:	31

11. Shelf Life:..... 32

12. Maintenance:..... 32

13. Disposal:..... 32

14. Test Procedures: 32

 14.1 Round Trip Efficiency Test: 32

 14.2 Performance Data:..... 34

 15.3 Test Method for Self-Discharge:..... 35

15. FAQs:..... 36

1. Safety Instructions:

This manual contains instructions for unpacking, mounting, installation and operation of a Sirius Module. Please read this manual carefully before operating the system and follow all warnings and safety instructions to prevent accidents. The Sirius Module must be installed by trained personnel.

1.1 Symbols Convention:

Safety instructions and general information that appears in this manual are described.



Caution!

“Caution” indicates hazardous situation which, if not avoided could result in minor or moderate injury.



Warning!

“Warning” indicates hazardous situation which, if not avoided could result in major injury or death.



Danger!

“Danger” indicates hazardous situation which, if not avoided could result in serious injury or death.



Note!

‘Note’ provides tip that are valuable for optimal operation of your product.

1.2 Safety Precautions:

The Sirius Modules are designed to provide years of trouble-free operation. Proper handling is required to avoid damage to the Module. In particular the following precautions should be observed.

- **Personal Safety:**

- Always wear proper personal protective equipment (eyes protection, gloves and safety shoes).
- Always make sure charger is set as recommended.
- Always make sure chargers are disconnected while working on Modules.

- **Module Safety:**

- Do not subject the Module to strong impact.

- Do not crush or puncture the Module.
- Do not dispose the Module in a fire.
- Do not charge the Module when the temperature is below -30°C.
- Do not charge the Module when temperature is above 80°C.
- Do not operate the Module above the specified voltage.
- Under no circumstances charge/discharge the Module at more than 125A.
- Under no circumstance must the charging voltage exceed 55 V_{dc} for more than 60 seconds.
- Do not expose the Module to temperatures in excess of 80°C.
- Do not place the Module near a heat source, such as a fireplace.
- Do not disassemble the Module under any circumstances.
- Do not touch the Module with wet hands.
- Do not expose the Module to moisture or liquids.
- Keep the Module away from children and animals.
- Ensure precautions to prevent short-circuit under all circumstances.
- Do not connect or disconnect terminals from the Module without first disconnecting the load.
- Do not touch the terminals with conductors while the Module is charged. Serious burns, shock, or material fusing may occur.
- Protect surrounding electrical components from incidental contact.
- When connecting to external devices ensure that galvanic isolation does not exceed 1000V.
- Do not use the Module in open-environment, in rain or in a place exposed to water and other liquids.
- Do not subject the Module to high pressure.
- It is not recommended to stack more than 3 Modules.
- Do not step on the Module.
- Do not drop the Module. Internal damage may occur that will not be visible.
- Do not stack Modules once they have been removed from the packaging, instead the Modules should be placed on shelving.
- In case the Module is physically damaged due to any event, do not install and energize the Module under any circumstances and immediately contact your Reseller.

1.3 Modules Connection Safety Precautions:

- All Modules must be at 100% SOC before connecting in Series or in Parallel.
- Series Connection of Modules is not allowed.

→ Modules cannot be connected in Series-Parallel combination under any circumstance.

1.4 Shipping:

Sirius Capacitor Modules are shipped out via Air and Sea.

- If the Modules are shipped via Air, please follow the instructions given below:
 - Carefully remove the nails from all the four sides of the wooden box and open it.
 - Remove the foam and cling wrap and open the carton box and lift the Module manually.
- If the Modules are shipped via Sea, please follow the instructions below:
 - Carefully remove the Module from the pallets after cutting the packing strip holding the Modules to the shipping pallets.
 - Open the carton box and lift the Module manually.

1.5 Qualified Installer:

Selling and installation of this Module is only through the Company's Resellers who are trained on installation, operation and maintenance of the Sirius Modules.

2. Product Introduction:

2.1 Product Part Number:

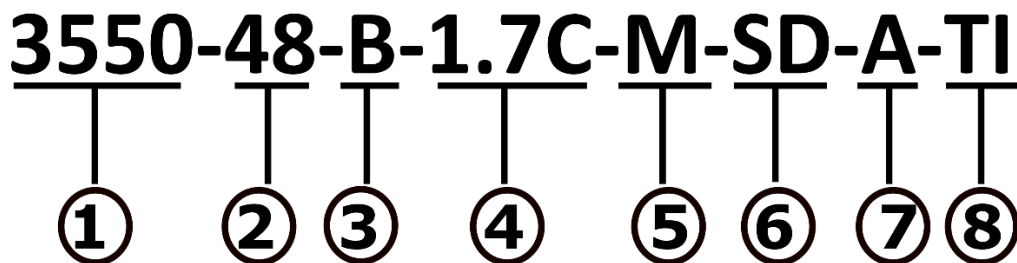

- 1) Capacity of Module in Wh
- 2) Nominal Voltage of the Module
- 3) Terminals are on the Front Side
- 4) Maximum Charge Rate of the Module
- 5) With Individual Cell Monitoring
- 6) With Safety
- 7) With Alarm
- 8) Temperature Insulation

2.2 Product Overview:

2.2.1 Appearance:

The appearance of the Sirius Module is shown below:

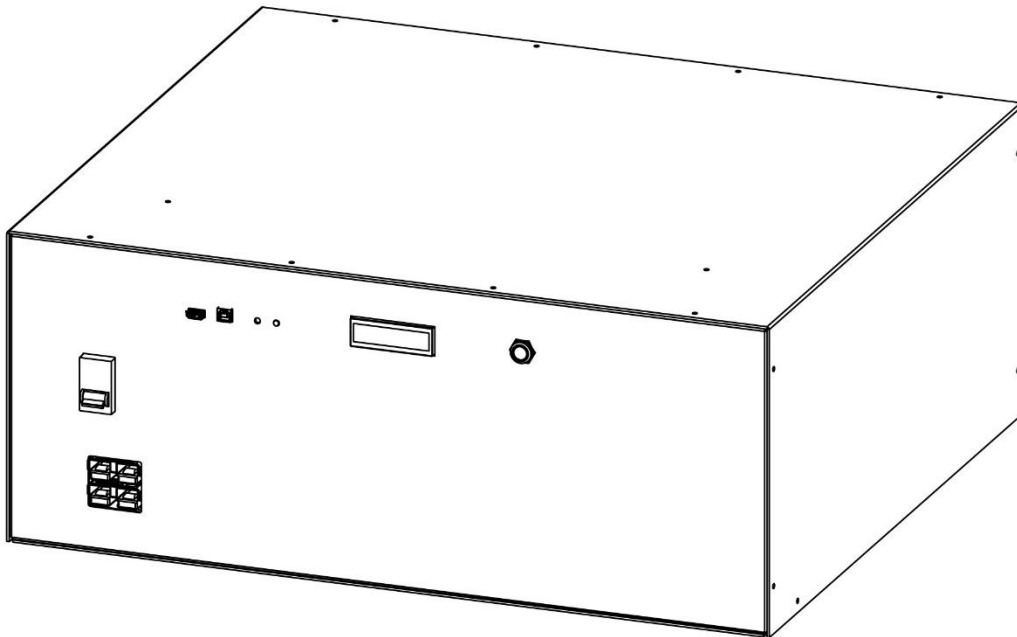

2.2.2 Mechanical Drawings:

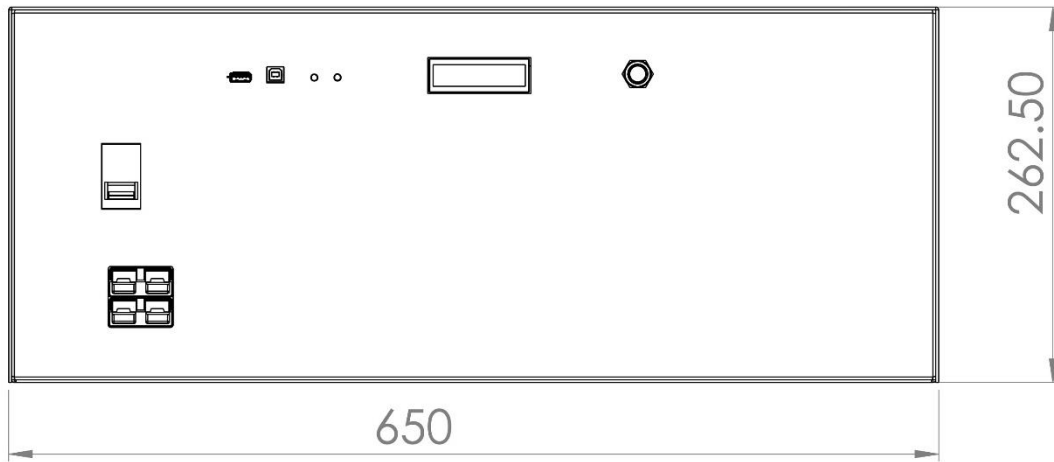

Front View



Side View

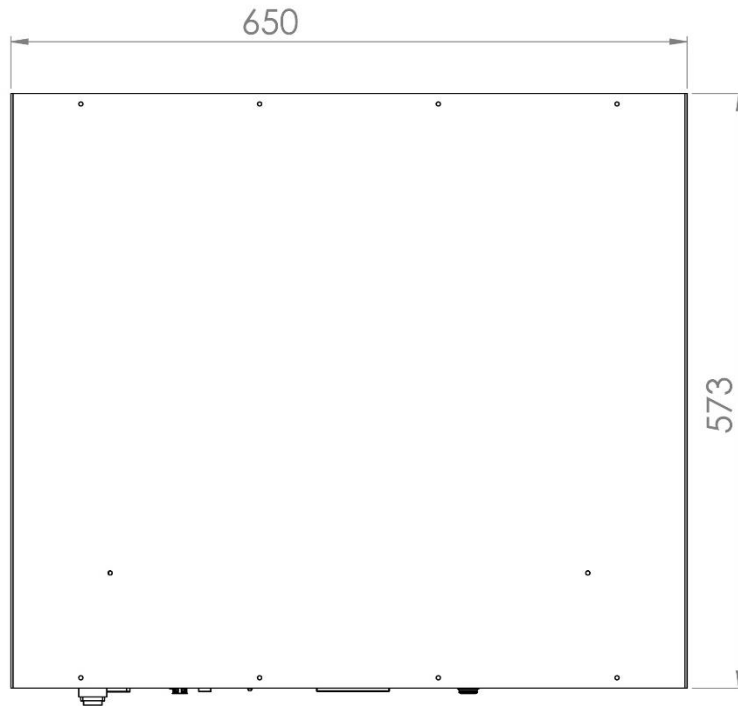

Top View

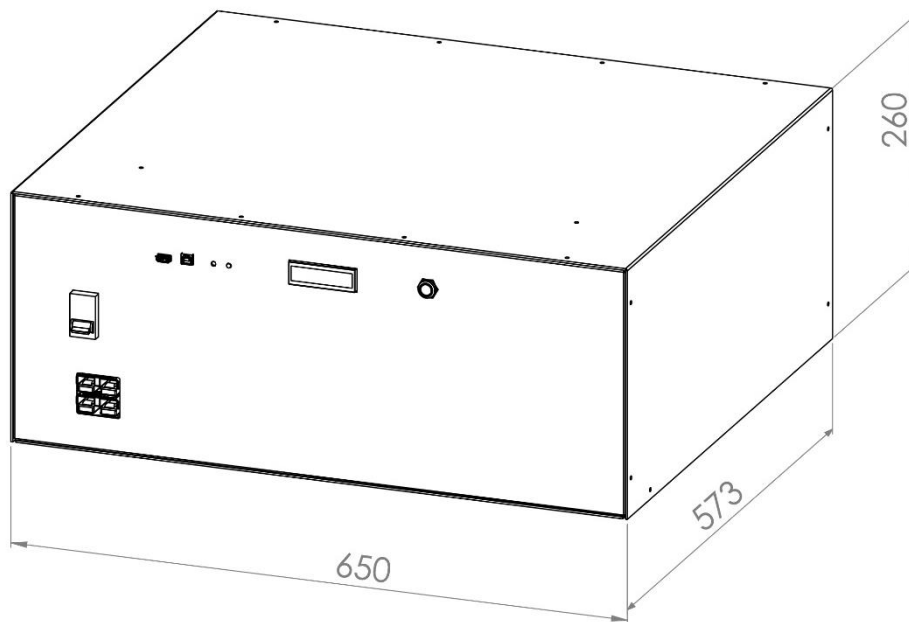

Isometric View

2.2.3 Dimensions and Weight:

Width	650 mm
Depth	573 mm
Height	260 mm
Weight	75 kg

2.3 Product Description:

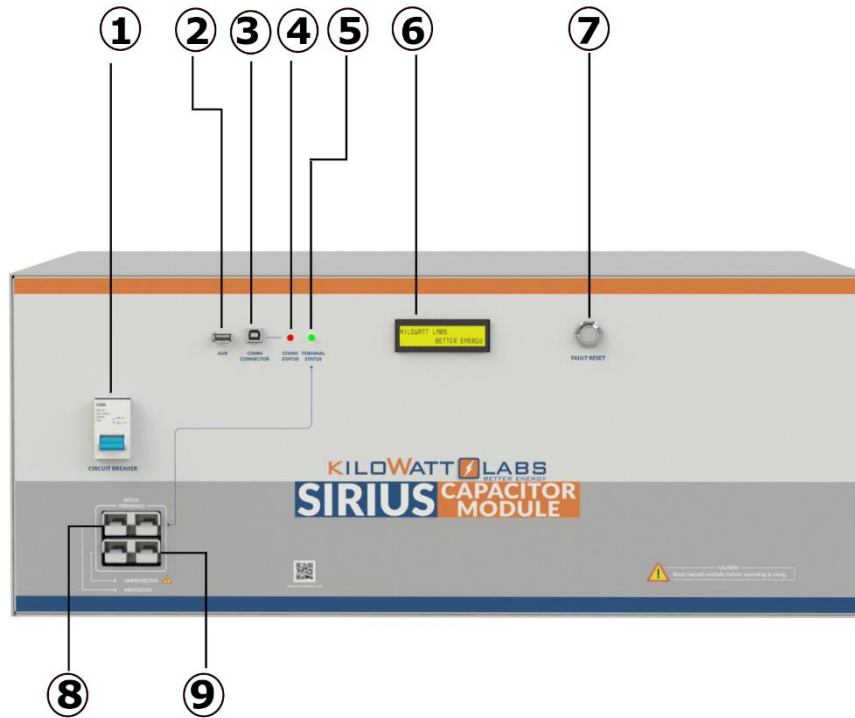

Object	Mark	Description
1	Circuit Breaker	C100A Circuit breaker for switch ON/OFF Module.
2	Aux	Auxiliary USB
3	Comm Connector	Communication Connector USB
4	Comm Status	Communication Status LED
5	Terminal Status	Terminal Status LED
6	LCD	(16x2) LCD
7	Fault Reset	Fault Reset Button
8	Protective Terminals	Protective Terminals
9	Unprotected Terminals	Unprotected Terminals

1. Circuit Breaker:

Circuit breaker is used to power ON the Module. It also acts as a second line of protection, if the circuit fails to protect the Module from over current, the circuit breaker will trip.

2. Auxiliary USB:

This is an auxiliary connector with isolated UART or Serial Communication for wireless monitoring, Module Combiner and future functions.

3. COMM Connector USB:

This is a COMM connector to monitor the Module using the Sirius software. FTDi chip is used for this USB.

4. COMM Status LED:

COMM Status LED indicates the communication status.

- **LED Status Indication:**

Color	Status	Indication
Red	Blinking	Control Module is communicating with Sirius VIEW Software.
Red	Steady	Control Module is not communicating with Sirius VIEW Software.
Red	Dimming	Module is in power down state.

5. Terminal Status LED:

Terminal status LED indicates the F12 terminal status.

Color	Status	Indication
Green	ON	The F12 terminal is active
Green	OFF	The F12 terminal is not active.

6. LCD Description:

Once the power is switched ON from the circuit breaker, the Module gets power and the LCD shows the following message after 3seconds under normal operation:

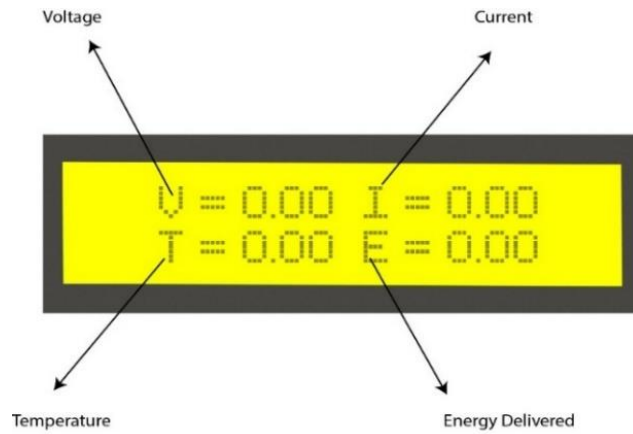

→ After 1 second, the following two LCD screens get switched with each other.

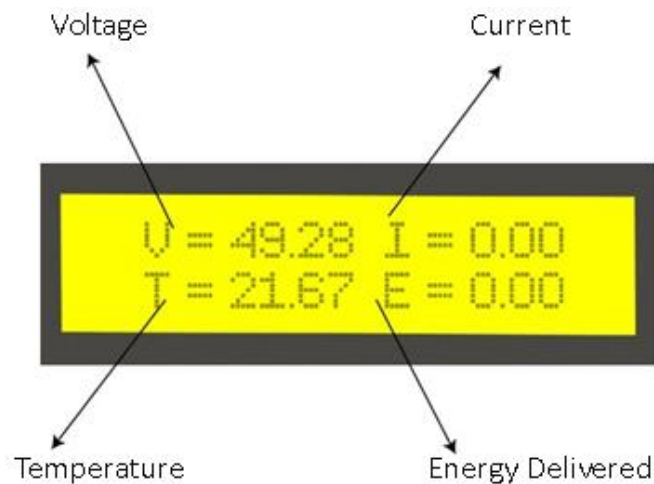
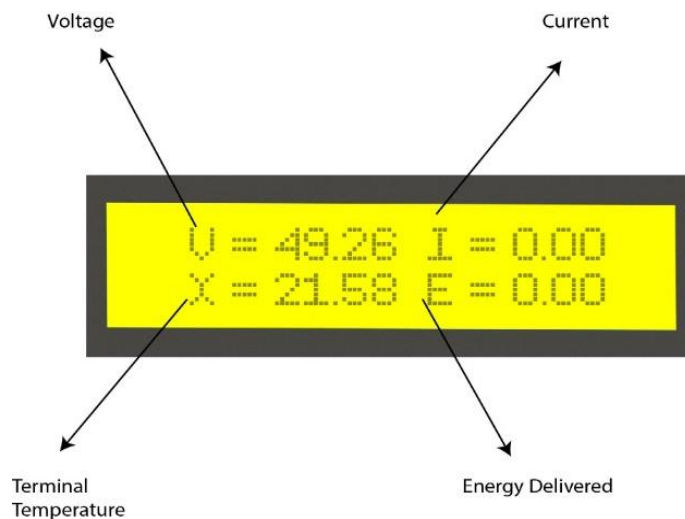

7. Fault Reset:

Fault Reset is a push button which is used to turn ON the terminals manually after it turns OFF due to any error.

The additional features of fault reset are as follows:

- a) Hold fault reset for 5 seconds to toggle the terminal.
- b) Hold fault reset for 3 seconds to reset fault if there is/are any.
- c) Press fault reset button to check the state of charge and instantaneous power.
- d) We can set the Current reading to zero.
- e) Press the fault reset button to see the individual cell voltages.

- **Checking for Individual Cell Voltages:**

When the fault reset button is pressed, the LCD after displaying the state of charge (SOC) and instantaneous power, will display the cell voltages of the first four cells as shown below:



Whereas:

01=Voltage of 1st Cell

02=Voltage of 2nd Cell

03=Voltage of 3rd Cell

04=Voltage of 4th Cell

By continuously pressing, the cell voltages will be displayed for all the cells.

- **Enabling/Disabling Cell Balancing:**

After scrolling through the individual cell voltages, cell balancing can be enabled/disabled by the following steps below:

Step 1: When current is zero, LCD will display the message as illustrated below.



Step 2: After this message appears, hold fault reset button for 5 seconds, then the LCD will display the following message which means that the cell balancing has been enabled.



Step 3: To disable cell balancing, when current is zero, the LCD will display the following message.



Step 4: After this message appears, hold the fault reset button for 5 seconds, then when the LCD displays the following message, it means that balancing has been disabled.



 **Note!**
To enable and disable balancing, the Current should always be zero.

 **Note!**
Balancing is automatically disabled if there is a Current reading greater than zero.

Step 5: To make the current zero, follow the steps below:

→ When current is not zero, the LCD will display the following message.



→ To make the current zero, hold the fault reset button for 3 seconds and the LCD will display the following message.



This means that the current is now zero.

To return back to the normal screen, press the fault reset button once more or leave the Module idle for 5 seconds.



Note!
Make sure that there is no external load or charger before setting the current to zero.

- To make the current zero, follow the steps below:
- When current is not zero, the LCD will display the following message.



- To make the current zero, hold the fault reset button for 3 seconds and the LCD will display the following message.



This means that the current is now zero.

To return back to the normal screen, press the fault reset button once more or leave the Module idle for 5 seconds.



Note!
Make sure that there are no external loads or charger before setting the current to zero.

8. Protected Terminal:

This is the output terminal of the Module which has electronic switch protection that is limited to 100VDC only.



Note!
Do not use protected terminal when connecting the Module in series.

9. Unprotected Terminal:

This is the second terminal of the Module which is used for series connection and recovery. Although the name implies unprotected, this terminal is still protected with the DC circuit breaker.

3. Module Installation:

3.1 Inspection:

Inspect the shipping carton for visible damage including cracks, dents, deformation and other visible abnormalities prior to unpacking the Module. Document (photograph) any damage and report this to your Reseller as well as to the shipping agent immediately. Remove the Module from the shipping carton and retain the shipping materials until the unit has been inspected and is determined to be operational.

3.2 Safety Gear:

Installation must strictly follow the national safety regulations in compliance with the enclosure, installation, creepage, clearance, casualty, markings and segregation requirements of the end-use application. Installation must be performed by professional installers only. Switch OFF the system and check for hazardous voltages before altering any connection! Sirius Modules must be handled only by qualified and trained personnel. Installation should not exert bending or twisting torque to the Module enclosure.



Note!
Read the safety Instruction section before installation.

3.3 Unpacking and Contents Check:

Check the contents of the package.

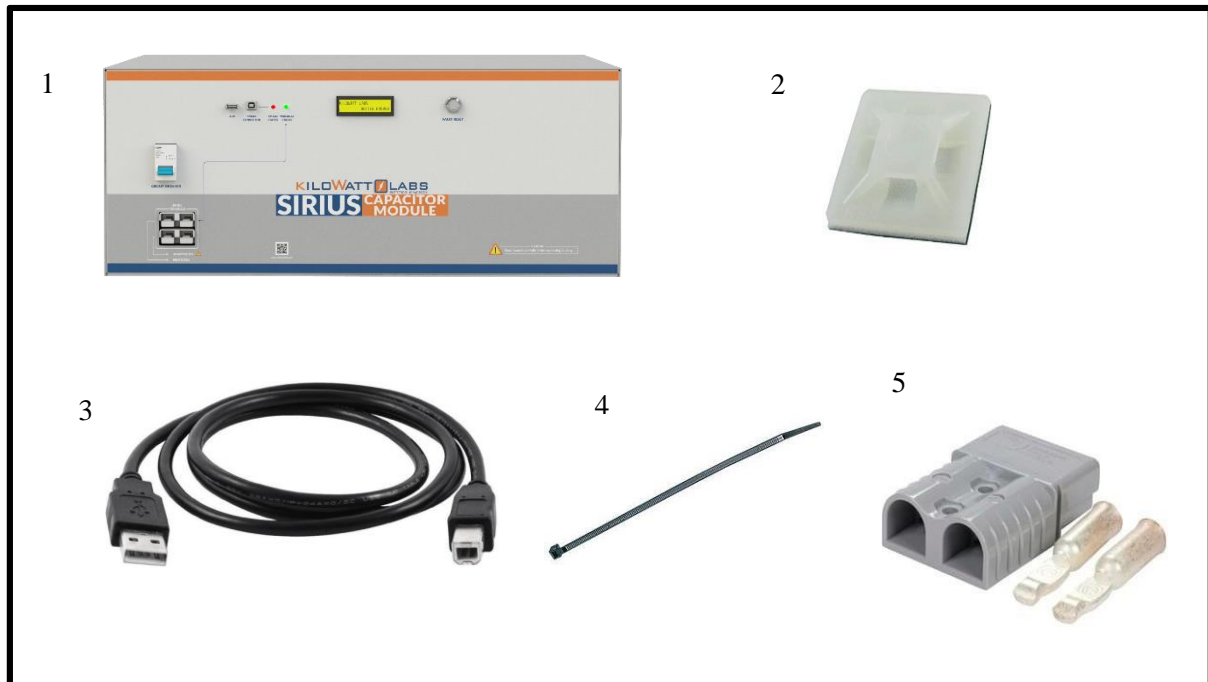

- 1) Sirius Capacitor Module: 3.55KWh48VDC
- 2) Cable tie support
- 3) USB cable A-B
- 4) Cable tie
- 5) 2 × Anderson Connectors with lug

4. Operation Procedures:

4.1 Module Configuration:

Follow the steps below to switch ON the Module.

Step 1: Connection of Cables to Anderson Connectors:

First connect the Anderson Connector to the Cables of the Module, by following the steps below:

- Take Anderson Connector as shown in the picture.

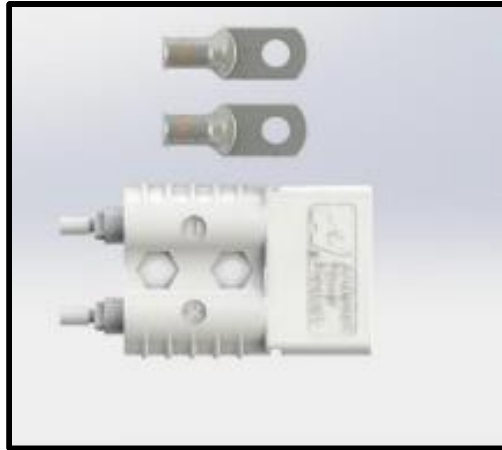

- Strip the insulation from the cable and gently twist the wire strands to keep them in contact (as shown in pic below).



- Put the wire strands into the Anderson connector lugs and crimp tightly down. Once crimped, pull the connector to make sure it is firmly attached to the wires. After crimping, the connector is as shown in the picture.



- Hold the housing and place the connector into the back of the housing and push it tightly. Make sure the Anderson connector is firmly hooked.



Step 2: Connecting the Load:

Connect the Anderson Connector to the Protected terminal of the Module as shown in picture below:



Note!

Use the Unprotected terminal to connect the Modules in series and for recovery purpose.

Step 3: Module Start-Up:

1. Turn **ON** the circuit breaker by pushing the Blue button upwards as shown in the picture below:



2. The picture below shows that the Module is turned **ON**.

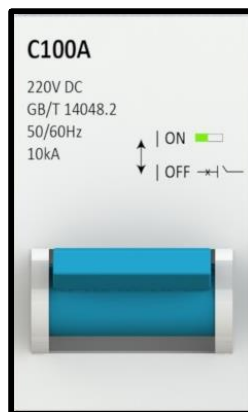

3. Be sure you are able to see the terminal status LED **OFF**.
4. Wait till the LCD screen on the Module displays initial values.
5. Press and hold the fault reset button, after 3 seconds the terminal status LED will change to Green.
6. Release the fault reset button.



Note!

Due to shipping laws and regulations, the Module may be shipped in partial state of charge.

Step 4: Module Shut-Down:

1. Press and hold the fault reset button to turn OFF the terminal. After 3 seconds the terminal status LED will go **OFF**.
2. Make sure every indicator on the Module is **OFF**.
3. Turn **OFF** the Module by moving the Circuit breaker button to the **OFF** position.



Note!
Always turn **OFF** the Module when not in use because it is self-powered. If left on, the self-discharge rate will increase.

4.2 Software Configuration:

To configure **Sirius VIEW** application, please follow the steps below.

1. Install the **Sirius VIEW** application on your system.
2. Connect the USB cable to the COMM connector USB slot to start communication and monitoring.
3. Turn on the Sirius Module by pressing the fault reset button on front panel.
4. Wait till the LCD screen on the Module displays initial values.
5. Double click on the **Sirius VIEW** application to execute it.
6. When the Log-In appears, enter the default username and password as shown below.

Default Username: admin

Default Password:123

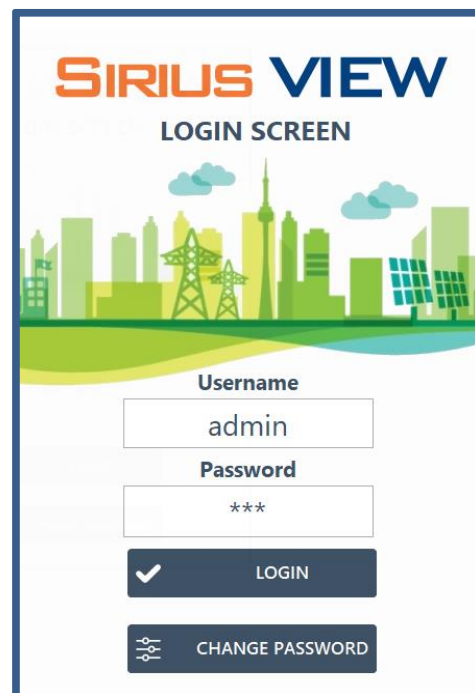
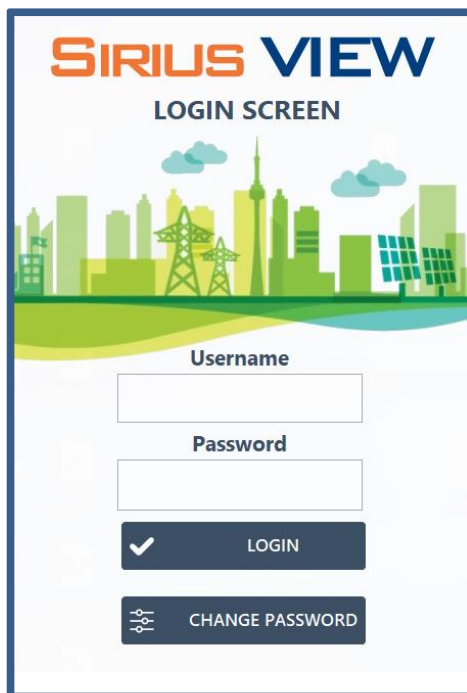

7. By clicking on Login, the below pop-up messages will appear.

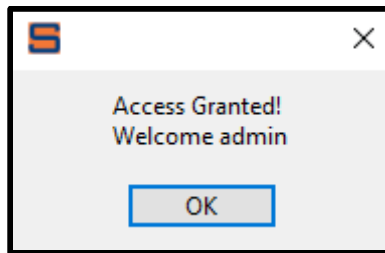
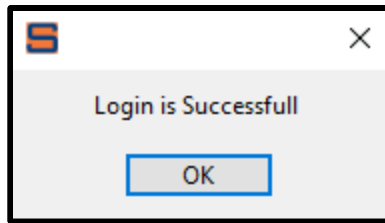

8. Keep on clicking OK until Sirius VIEW Monitoring Software window appears as shown below. Select **Sirius VIEW** and left click.

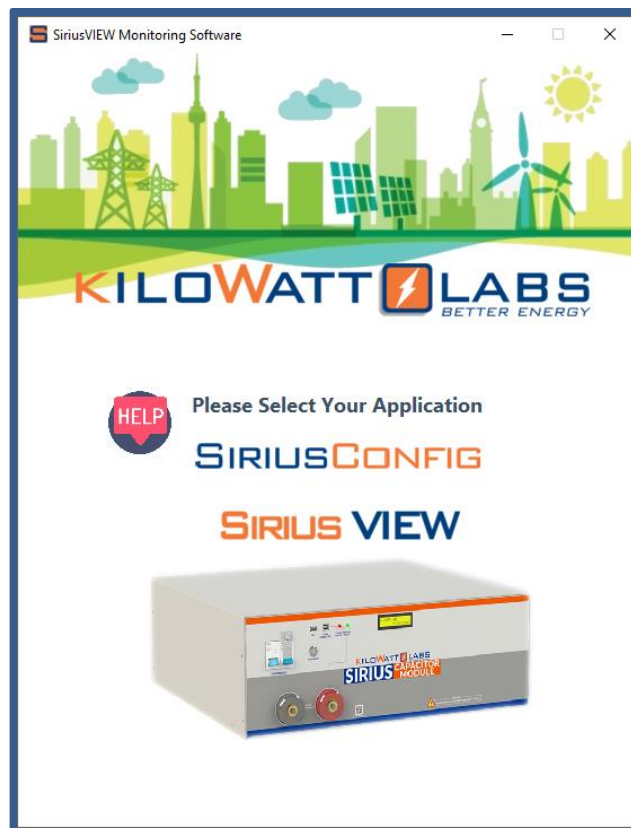

9. Follow instructions and press Run button on interface. (Auto Pop-up dialogs).

10. When the connection between PC and Module is established successfully, INIT.LED will be constantly turned ON.

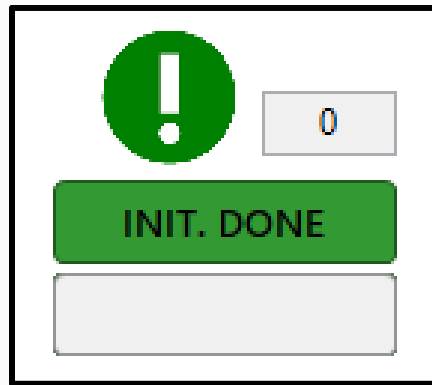

11. For getting measurement, press RUN button.
12. If there is any problem during connection, check USB cable and ensure the Module is working properly.
13. While getting measurement, MEASURING LED should blink every 1 second. If blinking has stopped, it will represent measurement interrupt or technical issues.
14. While getting measurement, COMM LED on front panel of the Module will blink.



Note!

Please read the Application manual to configure the software thoroughly. The Application manual is downloaded automatically when you install Sirius VIEW application.

5. Recovery Procedure:

When the Module voltage drops below a certain threshold, the control electronics are turned **OFF**. To restart the control electronics, follow the steps below:

1. Use the Unprotected terminal to turn the Module **ON**.
2. A power supply having a voltage range of 44Vdc to 54Vdc and current range of 1A to 10A will be required.
3. Connect the **positive** terminal of the power supply to the **positive** terminal of the Unprotected terminal and **negative** terminal of the power supply to the **negative** terminal of the Unprotected terminal using the lead provided.
4. Once the connection is done, turn **ON** the circuit breaker, the Module will recharge, and the control electronics will turn **ON**.
5. The event may take several minutes depending on the power supply used.

6. At this stage, remove the power supply and leave the Module for normal recharge.

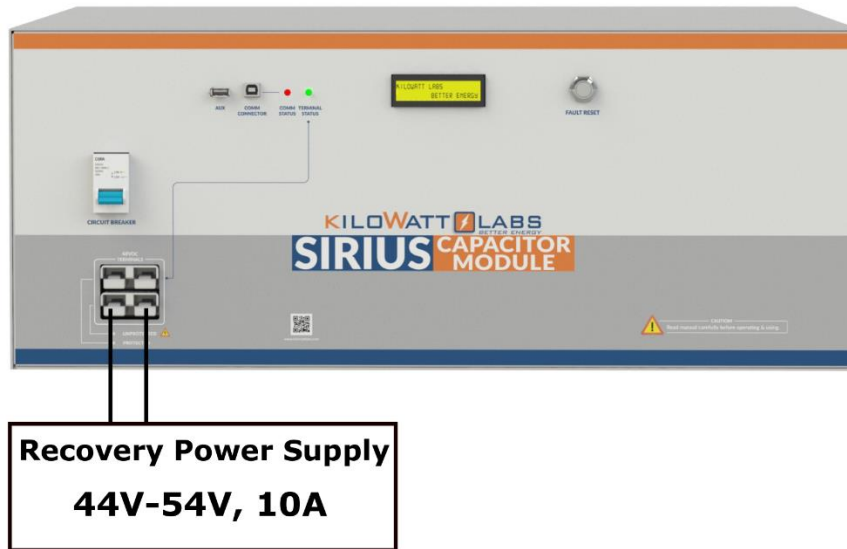

7. Recommended Charger for Recovery:

Maximum Current	10 A
Recommended Voltage	44V-54V



Caution!
Do not use more than 10A to recover the Module.

6. Connecting the Modules in Parallel or in Series:

The capacity or voltage of the Modules can be increased by connecting them in parallel or series respectively.

6.1 Parallel Connection of Sirius Modules:

Any number of Modules can be connected in parallel.

- Steps to Connect Modules in Parallel:**

Refer to the parallel combination of the Sirius Modules as shown below and make your connections accordingly.

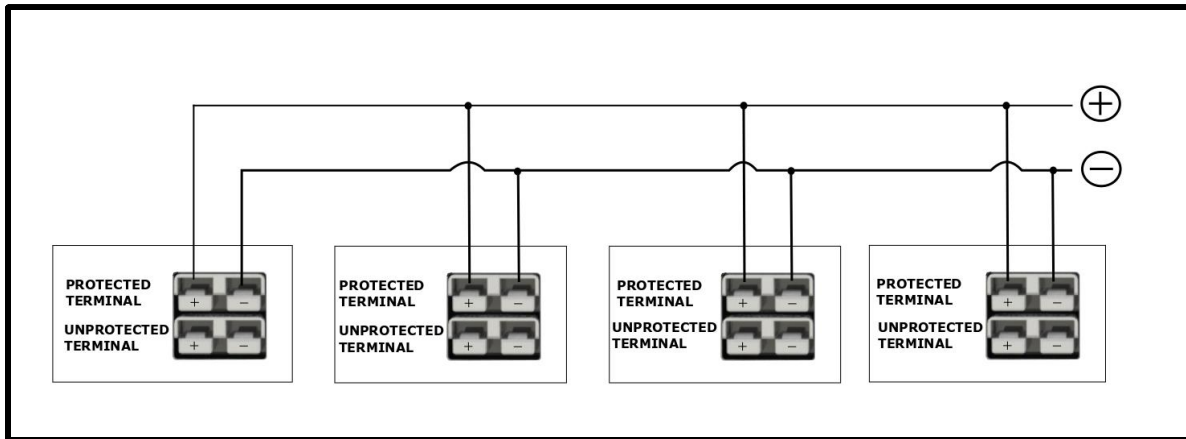

- Connect the **positive (+)** of the **Protected Terminal** of all Modules.
- Connect the **negative (-)** of the **Protected Terminal** of all Modules.



Note!

Use only the protected terminal when connecting in parallel.

- Take out the output positive and output negative from the respective common point.

6.2 Series Connection of Sirius Modules:

A maximum of 8 modules can be connected in series with a Module Combiner.



Caution!

Charge all the Modules to 100% SOC or alternatively to the same voltage before connecting them in parallel.

- **Steps to Connect Modules in Series:**

Refer to the series combination of the Sirius modules as shown below and make your connections accordingly.

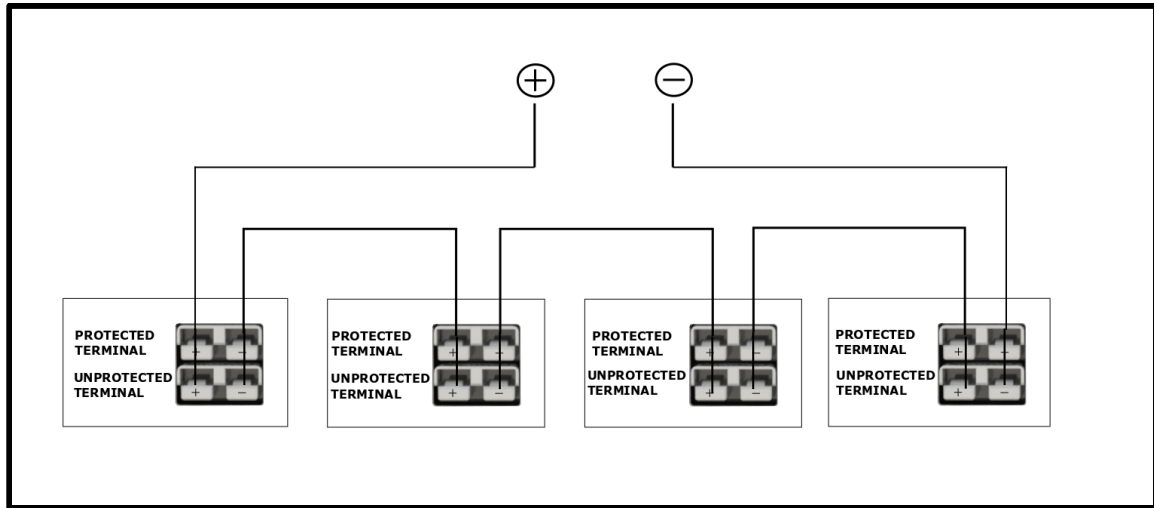

- Connect the **negative (-)** of the **Unprotected Terminal** of the first Module with the **positive (+)** of the **Unprotected terminal** of the next Module.
- Take the Output Positive from **first Module** and Output Negative from the **last Module**.



Note!

Use only the Unprotected terminal when connecting in Series.



Caution!

Charge all the Modules to 100% SOC or same voltage level before connecting them in Series.



Note!

Modules cannot be connected in series-parallel combination under any circumstance.

7. Resistive Heater:

A 48V resistive heater is used in the Module that draws up to 6A of current. When the temperature of the Module reaches 2°C, resistive heater is enabled. It is active for 6 minutes to allow temperature rise. After 6 minutes, it gets disable for 3 minutes to allow heat dissipation inside the Module and check itself for recovery. If the temperature of the Module will be 4°C, resistive heater will be recovered else it will again be enabled.

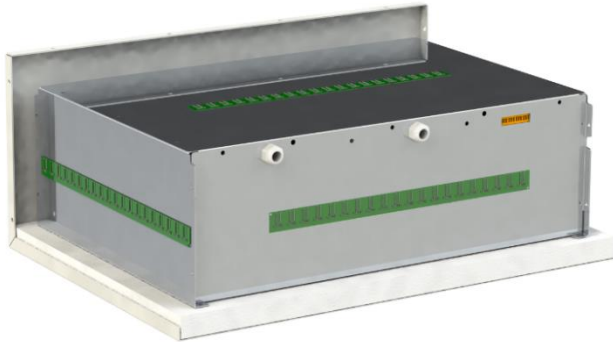

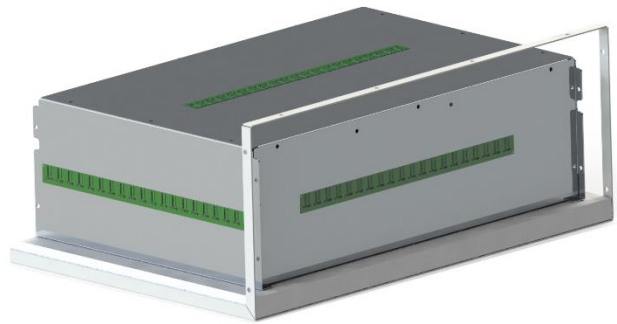

Front view of Internal case







Back view of internal Case

8. Automatic Safety Shutdown:

The Module will automatically shut down under any excessive use conditions in order to prevent damage to itself and to the connected equipment. Specified limits for excessive current, high voltage and low voltage are provided in Module’s technical data sheet.

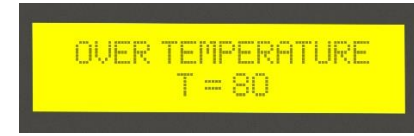
Cause of Shutdown	LCD Warning Message	Description
Over-Current (OCD)		When the Module has an Over-current fault, the counter counts for 5 seconds and if the current does not drop lower than the cut-off and count down has reached to zero, the buzzer alarms and the electronic switch will shut-down.
Module Charge Full		When the Module voltage reaches the maximum voltage, the electronic switch will shut down. This means that each cell from the Module has reached to maximum rated charge.
		The event will be repeated if the charger is still ON and operating in the same condition, the buzzer alarms and LCD will show the warning message.

Low Charge Module		When the Module is in standby mode and it reaches the minimum voltage, the LCD will display this message every 30 seconds.
		When the Module is connected to a load and it reaches the minimum voltage, the buzzer alarms, electronic switch will shut down and LCD will display the message.
Over-Temperature		When the Module has an Over-Temperature fault, the buzzer alarms, the electronic switch will shut down and LCD will display the message.
Terminal Over-Temperature		When the Module has a terminal Over-Temperature fault, the buzzer alarms, the electronic switch will shut down and LCD will display the message. This means that electronic switch has reached 80°C.

9. Trouble Shooting:

Check the indicators on the front panel to determine the state of the Module. A warning state is triggered when a condition, such as voltage, current or temperature, is beyond design limitations. When the Module falls outside prescribed limits, it enters a warning state. When a warning is reported, the Module immediately stops operation.

The possible warning messages are as follows:

Warning Messages	Description	Trouble Shooting
Over-Current (OC)	OC occurs when the current goes above 125A or when the Module is short-circuited. In this event, the electronic switch will shut down.	Switch OFF the circuit breaker and check the continuity across the Module terminals to find whether there is a short circuit. In case of a short circuit, check the operating circuitry and clear the short circuit.

<p>Over-Temperature (OT)</p>	<p>OT occurs when the Module temperature goes above 80°C. In this event, the electronic switch will shut down.</p>	<p>Shut down the Module and check the surrounding temperature and ensure the ambient temperature is less than 80°C. If not leave the Module to cool till the temperature comes below 80°C. Now, turn ON the circuit breaker.</p>
<p>Remove Module Charger/ Connect Module Charger</p>	<p>This happens when there is some residual current. In this event, the Module gives alarm for full charge or low charge and the charger/discharger is also disconnected but the electronic switch is not activated.</p>	<p>In Sirius VIEW application, select Sirius CONFIG then go to Calibrate Zero Current. Press Calibrate. If you see “No load current is set successfully”, it means the current is set to zero.</p>

10. Features:

10.1 Key Features:

- Low power consumption.
- Accurate SOC estimation.
- Detection of circuit board errors.
- Long service life.

10.2 Physical features:

1. Electronic switch is used to control the terminals in Sirius Module. It has more life period than AC or DC contactors and responds faster than any control methods.
2. Sirius Module has embedded functionality in the event of:
 - High Cell Voltage
 - Low Cell Voltage
 - High Terminal Voltage
 - Low Terminal Voltage
 - High Terminal Current
 - High Ambient Temperature
 - High Module Temperature
3. Front panel of Sirius Module has LCD and Fault Reset Button. The fault reset button acts as a multifunction button for monitoring and configuration. By using Reset fault Button and LCD user

can:

- Turn ON/OFF terminals of Module.
 - Read Cell Voltages, Instantaneous Power, SOC, Terminal Voltage, Terminal Current, Terminal Temperature and Ambient Temperature.
 - Recalibrating Current Measurement by configuring zero current values.
 - Activating Terminals to make Module more secure at first operation.
 - Snooze alarms in case of repeating Module alarms.
4. LCD contrast can be configured anytime over Sirius VIEW Monitoring application.
 5. Sirius Module can be used with Power Save Mode, this feature can be activated by Sirius VIEW Monitoring application.
 6. Front panel of Sirius Module also has 2 LEDs for letting user know the status of Module like
 - Communication LED (Red): Blinking while communicating.
 - Terminal LED(Green): Active while terminal is ON, Inactive while terminal is OFF.

10.3 Technical Features:

1. Sirius Module has one processor for alarm monitoring, communication and datalogging features.
2. Sirius Module has internal memory card that is logging every 10 seconds value of:
 - Terminal Voltage
 - Terminal Current
 - Module SOC
 - Ambient Temperature
 - Terminal Temperature
 - Time Stamp
3. Internal logged data can be easily extracted over Sirius VIEW Monitoring application. Size of internal memory is 8GB and Module can keep logging 30 days of data without any interruption.
4. User can delete and read SD card memory over Sirius VIEW Monitoring Application.
5. Sirius Module has one of the best ADC to increase measurement accuracy up to 6 μ V level.
6. Sirius Module has advanced algorithm to control Module in safest way. This algorithm can be upgraded by user with updating firmware of Sirius Module over Sirius VIEW Monitoring.
7. Sirius Module firmware can be customized easily based on user needs.
8. Sirius Module has USB interface to communicate with Host PC for:

- Measurement Monitoring
- Alarm Monitoring
- System Configuration
- Measurement Calibration
- Manual/Auto Data Logging\Module firmware updating
- Internal SD card reading/refreshing
- Statistical Analyzing/ Graphical result

11. Shelf Life:

Shelf life is the life of the Module in years from the date it is manufactured to the time it is first operated. The shelf life of supercapacitor cell is 10 years.

12. Maintenance:

The Sirius Module does not require periodic maintenance.

13. Disposal:

Dispose according to local regulation.

14. Test Procedures:

14.1 Round Trip Efficiency Test:

Round Trip efficiency test is performed to evaluate the performance of the Module. There are three factors to be considered in the design of the test cycle for round trip efficiency.

- How to charge and discharge the Sirius Module.
- At what voltage to start and end the charge/discharge?
- At which points to do the measurement.

Considering the efficiency and cost involved in the production line, we used constant current load test method for Round trip efficiency characterization.

Test Equipment:

- DC Charger test system or any other test system which can be used to charge and discharge Module with test cycle programming. We used **WRL48V80A27cd** DC Charger Motor for charging and **WRL-FDY48L20** Battery Discharge Tester for discharging.

Test Temperature:

- Room temperature 23°C ±2°C.
- Temperature controlled chamber can be used if testing at any environment other than room temperature.

Test Current:

- Different current within the maximum limit specified by the test equipment manufacturer can be applied to the test.
- We took test currents in the range of 20-70A with current steps of 10.

Test Process:

Step 1: Rest (open circuit):

- Record test time, test current, and voltage at the start of the test (t1, I1, V1).

Step 2: Charge Cycle:

- Charge voltage to its maximum voltage.
- Record test time, test current, voltage and total charge energy at the end of charge cycle (t2, I2, V2, E1).

Step 3: Discharge Cycle:

- Discharge Module to its minimum voltage.
- Record test time, test current, voltage and total discharge energy at the end of discharge cycle (t3, I3, V3, E2).

Step 4: Round Trip Efficiency Calculation:

$$\text{Round trip efficiency} = \left[\frac{\text{total discharge energy (E2)}}{\text{total charge energy (E1)}} \right] \times 100$$

14.2 Performance Data:

Total Voltage During Charge Cycle:

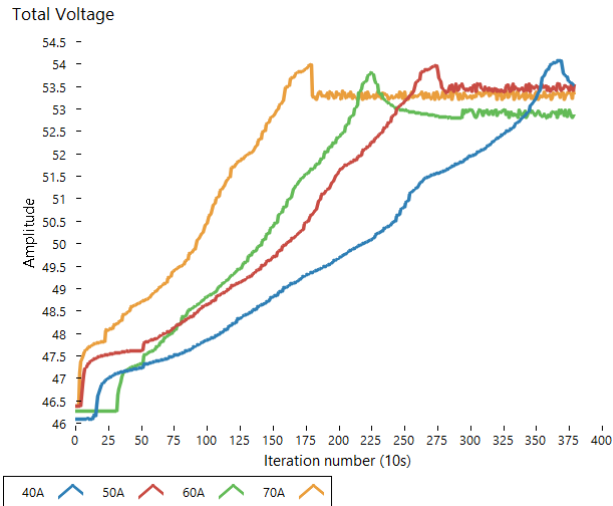

Ambient temperature During Charge Cycle:

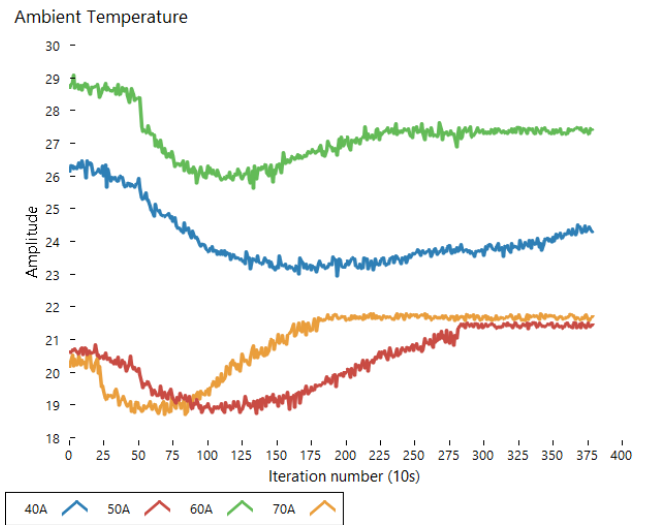

- It can be seen from the graph that as charge current is increased, the time required for making Module full charge is decreased.
- The Module behavior with different charge currents is quite similar. Total voltage level dramatically increases from 46V to 47.5V in less than 2 minutes and have linear behavior between 48V to 53V.

- There is very small correlation between internal temperature and charge current rate. The maximum internal temperature increase is 1 Celsius regarding charge current rate.

Total Voltage During Discharging Cycle:

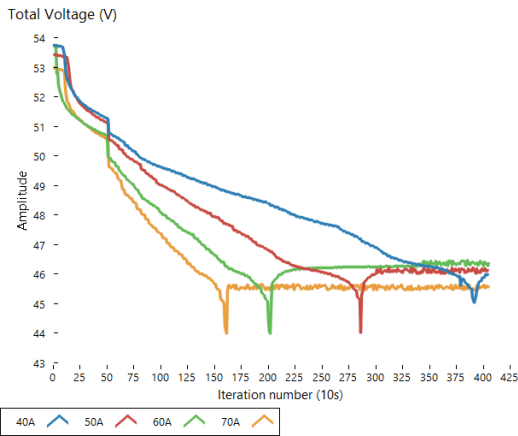

Total Voltage During Discharge Cycle:

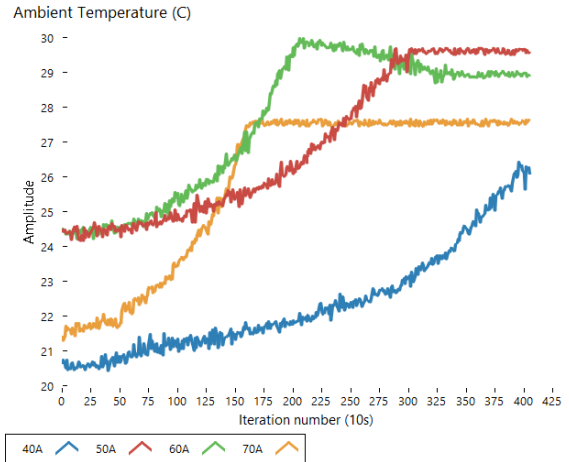

- It can be seen from the graph that as discharge current rate is increased, the time required to discharge the Module is decreased.
- Similar to Module charge graph, also while discharging, there is dramatic voltage decrease from 53V to 50V in less than 9 minutes regardless of discharge current rate. Between 50V to 44V there is linear behavior in all discharge voltage curves.

Regarding the discharge test with 4 different current rate, ambient temperature reaches the maximum value when Module is fully discharged and there is quite correlation between consumed energy and Module ambient temperature. Temperature increase window is 5 Celsius.

14.3 Test Method for Self-Discharge:

The self-discharge method is designed to see the natural decay of the Module’s total voltage over time after it is fully charged. The result will be influenced by the temperature, the voltage at which the device is charged and the aging condition.

The following steps describe the process for measuring self-discharge.

Step 1:

- Charge the battery to its maximum voltage.
- Record the voltage (Vmax).

Step2:

- Leave the battery idle for a period of 1 month.
- Record the open circuit voltage after 1 month (Voc).

Step 3:

- Self-discharge (%) = $\left[\frac{V_{\max} - V_{oc}}{V_{oc}} \right] \times 100$
-

15. FAQs:

Q. How to determine the current status (charging/discharging)?

A. When the current value on the LCD is negative it means the Module is discharging and when it is positive, it means the Module is charging.

Q. The current reading on the LCD is not accurate for the first charging/discharging Session?

A. The user should wait for 5 minutes after starting the Module for the first charge/discharge session (it is only one time for warming up).

Q. Can we use unprotected terminal while the Module is switched OFF/ON (For Anderson Terminals)?

A. Module is ON: There will be an output voltage measured across the unprotected terminal, however the protected terminal can be toggled ON/OFF by using fault rest button, but if 'activation safety' option is checked OFF from the Sirius VIEW application, the protected terminal will be ON all the time. (Please refer to alarm and calibration status section in Sirius VIEW application manual and Operation Procedure section in user manual).

Module is OFF: Both of the terminals will not work when the Module is switched OFF.

Q. The Module shows zero current while using unprotected terminal for recovery (For Anderson Terminals)?

A. Please consult with your Reseller.

Q. How to reset the current to zero?

A. Please refer to section 2.3 in User Manual.

Q. If we leave the Module turned ON after it reaches 44V or below. What will happen?

A. When the Module reaches the minimum voltage and below (whether terminal is ON or OFF), the LCD will display "Low Charge Module" message. (Please refer to Low charge module section in user manual).

Q. What will happen if the Module is totally empty? or If the Module is left on after it is drained, will it keep draining to the point that it will not charge without some sort of manual recovery?

A. Getting Module totally empty (zero voltage) after leaving the Module stand by for long time is normal, so in this case LCD & electronic switch will be OFF, but the Module can be recovered. (Please refer to recovery procedure in the user manual).

Q. Self-consumption of the Module when connected to a power source and the terminal is ON, seem to consume about 1Amp or about 1kWh per day?

A. The maximum current of the Module BMS is 60mA not 1A.

Q. We are getting multimeter value different (Voltage, Current Charge/discharge, Temperature, Energy) from that displayed in LCD across the terminal? or why has the Module lost the calibration?

A. It is normal since each electronic tool or equipment needs calibration after long time of use to get accurate results, and for that the Module needs to be calibrated. But before that please check the following:

- Firstly, double check the value with accurate meter (we suggest Fluke multimeter), if the deviation between the Module and multimeter is less than $\pm 0.5\%$ it is acceptable.
- Secondly, if the deviation is more than $\pm 0.5\%$, the Module needs calibration. Please consult with your Reseller for calibration.

Q. What could happen when connecting different model of Sirius Module parallel/series together?

A. Modules can be connected in parallel or in series if they will have:

- Same Voltage
- Same Capacity

It is possible but not recommended especially connecting old BMS design to the new one. The system might get unpredictable during extreme scenarios like Module charge full or low.

Q. Is it possible to connect Sirius Module in parallel with other chemical batteries such as lithium-ion or lead acid?

A. It is possible but not recommended. Make sure the total voltage of each battery is the same as the Module and the charging voltage does not exceed the Module's maximum voltage. The possible drawback is that you will not get the total capacity of the chemical battery because extreme voltages are not the same.

Q. If we set the cutoff voltage on the charge controller systems /inverter end to 45V, will that allow the Module to sit at idle for longer periods of time to avoid an undervoltage situation.

A. Yes.

Q. Which is most compatible charge controller systems/ inverter, and whether any charge controllers have been integrated with Sirius in this application?

A. All charge controllers that are compatible with our Module specification (please refer to user manual of Module) can be used with Sirius Module, however you must follow the charging curve of Sirius module.

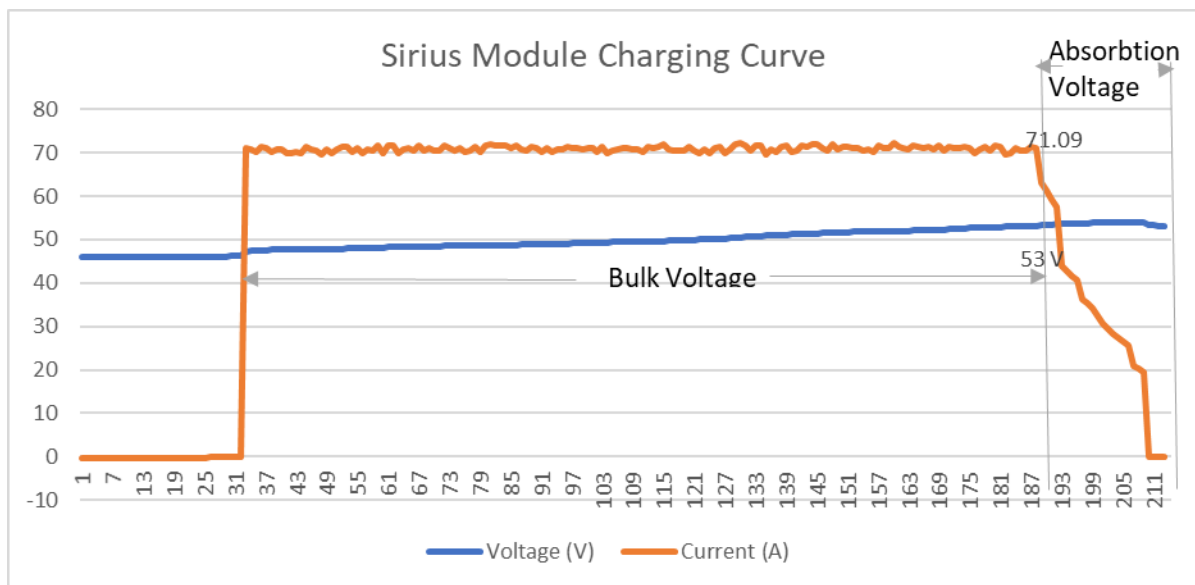

Figure 1: Sirius Module charging curve.

Also, Kilowatt labs can provide Centauri Energy Server for microgrid system for more information please visit www.kilowattlabs.com.

Q. How to check charging/discharging energy of Module?

A. Please refer to "Overview of Sirius VIEW Application" section in Sirius VIEW application manual.

Q. How to reach the rated capacity of Module?

A. The display shows the total delivered energy (discharged) from the time the Module started till current time, and the Module has ~74 A at 1C and 125A at 1.7C(Max. charging current). So, to obtain the standard energy 3.55kWh, start the charging cycle from minimum voltage 44V to maximum voltage 54V with constant current of 74 A as shown in charging curve of Sirius Module, then for discharging cycle start from maximum voltage 54V to minimum voltage 44V with 74 A constant

current. (Please refer to Sirius VIEW application manual for Round trip efficiency).

Q. What would be the effect on energy when charge/discharge the Module at different C-ratings?

A. When the charge rate increases, the time for charging/discharging decreases, which means that maximum energy can be obtained in a short period of time as shown in the table below.

Table 1: Charge rate with its corresponding time.

Charge rate (C)	Charging current (Amp)	Discharging current (Amp)	Time (Minutes)
0.28	20	20	Approx. 4hrs
0.5	37	37	Approx. 2hrs
1	74	74	Approx. 1hr
1.35	100	100	45 mins
1.7	125	125	35 mins

Q. Why the Module needs twice of power cycle?

A. When the Module is switched OFF and the Sirius VIEW is still open you have to wait for 10 Sec (since the application is still communicating with the Module) before turning ON the Module, or either by terminating the Sirius VIEW or by disconnecting the communication cable.

Q. How much is the capacity of the internal storage (SD Card)?

A. 8GB SD Card is used in the Module which logs 85 bytes of data per 10 seconds. Note that data logging should be turned ON before the Module will start logging and data logging is limited to 30 days. After reading the data the Module will delete it automatically. By default, data logging is OFF for firmware version 2.0 and above.

Q. Do I need to use Sirius VIEW Software?

A. The Module can work stand-alone without the software however, the software can be used to monitor and extract the data & measurement as well as to enhance the performance of the Module.

Q. How do I know if there is firmware issue in the Module?

A. Please refer to Sirius VIEW monitoring software manual Configuration of Module and Software section.

Q. What kind of issues can happen about firewall and antivirus programs?

A. There will be no problem as far as the software run as administrator.

Q. How to calibrate Module parameters?

A. To calibrate Module parameter like (Voltage, Current, Temperature, Energy). Kindly consult with your Reseller for calibration procedure.

Q. What is the reason if the LED isn't working at all?

A. Due to different reasons that may happen such as:

- If we can get the output (Terminal, software communication), the LED may have some technical issues.
- The protected terminal is not working.

Please consult with your Reseller.

Q. How to troubleshoot the communication between the Module and PC?

A. If you face any communication difficulties between the Module and PC please troubleshoot as follows:

- Double Check the cable connection (try to use another USB cable).
- Try to use another port in the PC.
- Check the Module USB drive in your PC from setting then search for Device Manager then go to ports as shown below (Please refer to USB serial driver quick install).

After the troubleshooting if the problem still doesn't solve, please consult with your Reseller.

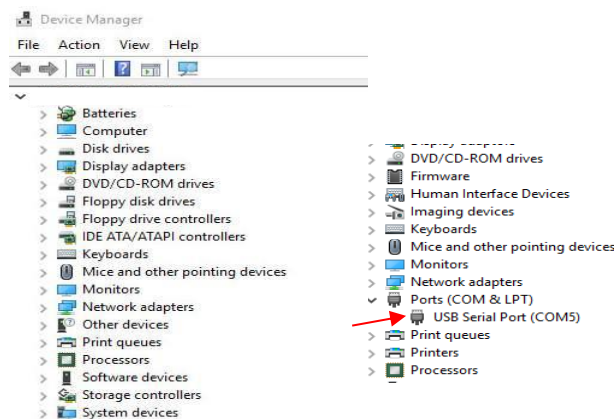

Figure: Module Port

Q. The Module is showing Contact Service.

A. Contact your Reseller for customer support.

Q. How to update the Firmware.

A. New Firmware is uploaded to <https://www.amberandwaseem.com/>. Always check the website for an update.

Q. The Module doesn't seem to show correct State of Charge (SOC).

A. The Module is using the previous data to correct the state of charge in the long run. Charge the Module to maximum Voltage and then discharge it to cut-off Voltage and repeat the process several times to correct the SOC. Note that open voltage is not directly related to SOC.

Q. Can the Sirius Module be installed standing vertically with the connection facing up without potentially stressing the cells inside the Module?

A. Yes, but NOT in a movable\vibrating position.

Q. What is the difference between the "balancing" and "auto balancing" in "set Config" tab in Sirius VIEW?

A. Balancing: Balancing can be activated from any voltage level when the Module is in standby mode (Zero current). When all the cells get balance, the balancing will stop. The time required to balance all cells depends on cells condition.

Auto balancing: Auto balancing is activated automatically during charging when the cells get unbalanced.

Note that it is activated only when the Module Voltage reaches ~52 V.

Q. Can balancing and auto balancing options be activated at a same time?

A. Yes.

Q. When to use Sirius Config?

A. The Module is received with full settings and the most updated firmware, however, if you want to calibrate parameters (current, voltage, date and time, alarm, temperature) you can use Sirius Config for calibrating. For more information contact your Reseller.